

Aircraft Environmental Control Systems (ECS) with Case Studies

Dr. Charles O'Neill
Remote Sensing Center
University of Alabama
croneill@eng.ua.edu
<http://aero.ua.edu>



It's the man, not the machine.
– Chuck Yeager

The objective of an Environmental Control System (ECS) is to sustain and nourish the pilot, humans, and other lifeforms aboard the vehicle. Aerospace ECS is a **life critical** requirement for aircraft and spacecraft.

Physics?

Operational Requirements?

Pilot Comfort?

Avionics?

Environment?

Signature?

Hostile?

Solar?



SWAP-C: Size, Weight, Access, Power, Cost?

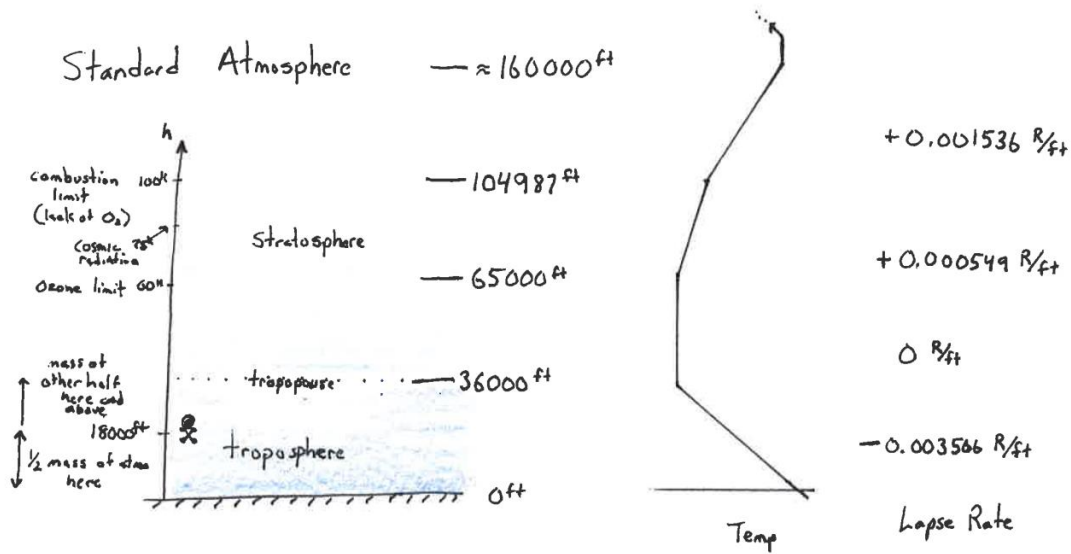

We are lucky to live at the bottom of an ocean of protective air.

- Death zone for humans begins around 20k ft or so...
- Half the mass of air is below 18k ft
- Ozone above 60k ft prevents use of outside air for humans.
- Cosmic radiation becomes significant around 75k ft.
- Normal jet combustion fails around 100k ft. (Not enough O_2)
- The positive lapse rate around 65k ft makes the atmosphere stable. Convection is minimal.

Non-dimensional P, T, ρ ratios

$$\delta = \frac{P}{P_{SSL}} \quad \theta = \frac{T}{T_{SSL}} \quad \sigma = \frac{\rho}{\rho_{SSL}} = \frac{\delta}{\theta}$$

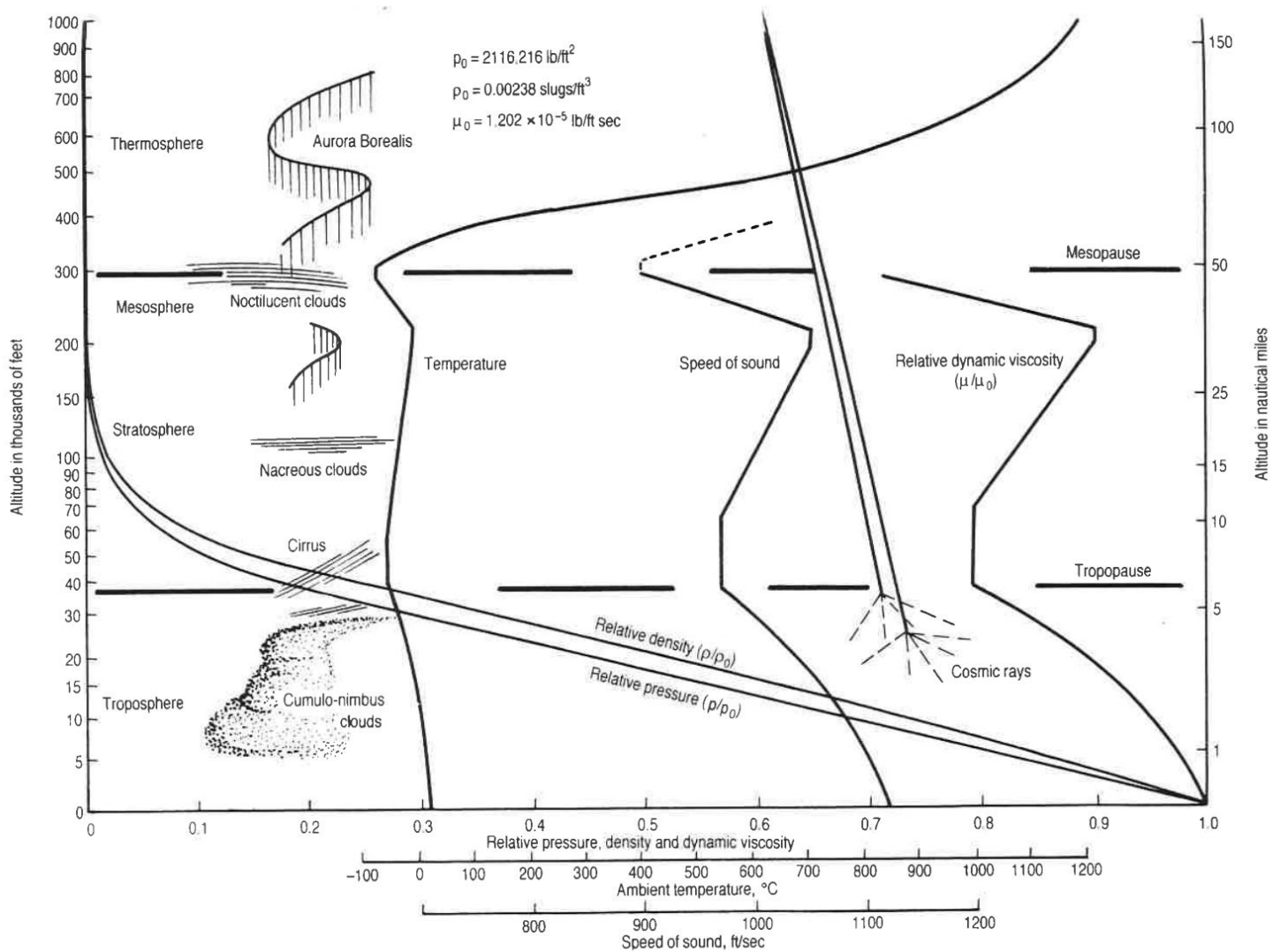
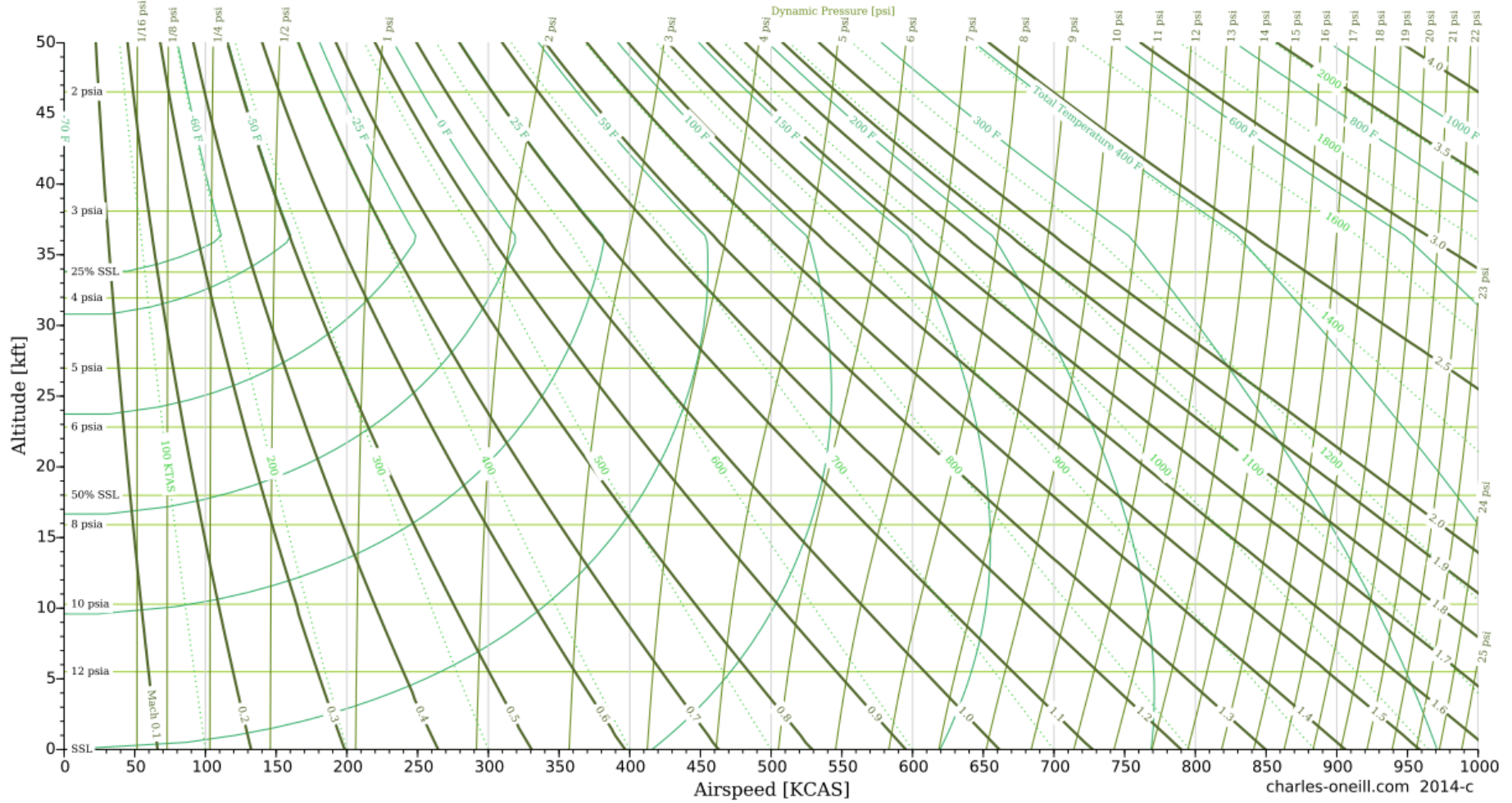

Fig. 1.2 General characteristics of the atmosphere (based upon ICAO and US Standard Atmosphere 1962).

Source: The Anatomy of the Airplane
Stanton

Flight Envelope



Oxygen: "take it or make it"

Take it { Bottle: Limited supply, simple
 Chemical: (e.g. Sodium Chlorate)
 1 time use (10-20 minutes)

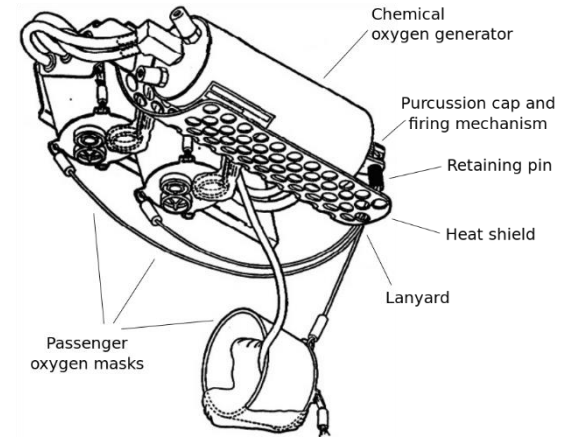
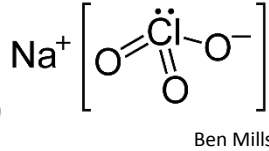

Make it { Pressurize existing air: Common
 OBOGS (Onboard Oxygen Generating System):

Valujet 592 Crash (NTSB)

Concept ③ Molecular Sieve (aka. Pressure Swing Adsorption)

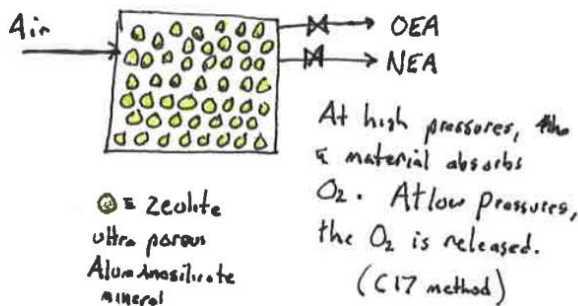

ALL U.S. F/A-18 HORNET MODELS AFFECTED BY OXYGEN DEPRIVATION AND CABIN DECOMPRESSION ISSUES

<https://theaviationist.com/2017/03/29/all-u-s-fa-18-hornet-models-affected-by-oxygen-deprivation-and-cabin-decompression-issues/>

Luke Air Force Base extends cancellation of F-35 flight operations

By: Valerie Insinna June 12, 2017

Since May 2, five 56th Fighter Wing pilots have reported symptoms of oxygen deprivation while flying the U.S. Air Force version of the joint strike fighter, including two incidents that occurred last week. In all cases, the <https://www.defensenews.com/air/2017/06/12/luke-air-force-base-extends-cancellation-of-f-35-flight-operations/>

F-22 grounding continues as oxygen safety probe widens

16 JUNE, 2011 | SOURCE: FLIGHT INTERNATIONAL | BY: STEPHEN TRIMBLE | WASHINGTON DC

<https://www.flightglobal.com/news/articles/f-22-grounding-continues-as-oxygen-safety-probe-wide-358103/>

pressurization

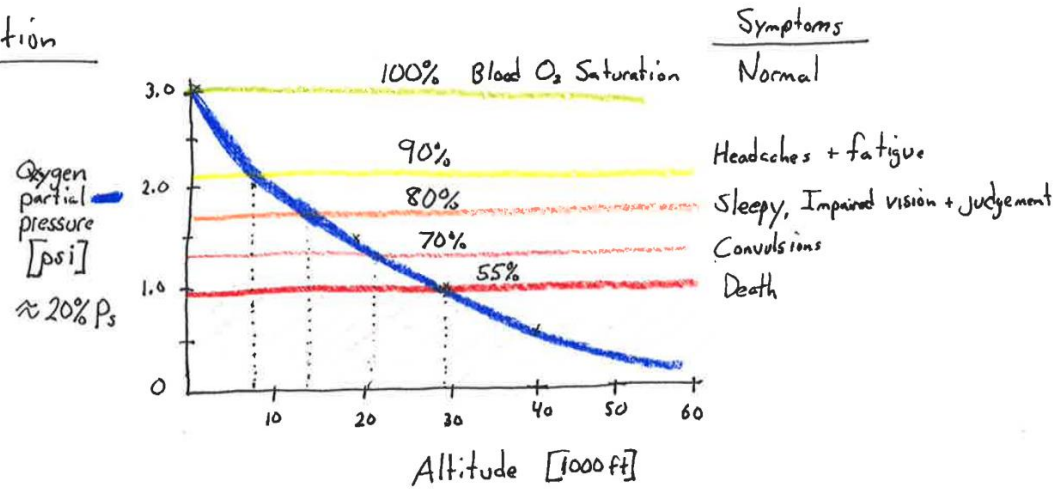

Federal Aviation Regulations

- Cabin must operate at an 8000 ft equivalent pressure or below if pressurized ($\approx 90\% O_2$ Sat or above)
 - 25000 ft Decompression for no more than 2 minutes
40000 ft Never
 - Private aircraft (not for hire) can operate:
 - > 12500 ft for less than 30 min without Oxygen
 - > 14000 with oxygen
- } this effectively drives the speed brake size on business jets

Mask or cannula

Bleed Air

Brayton Cycle

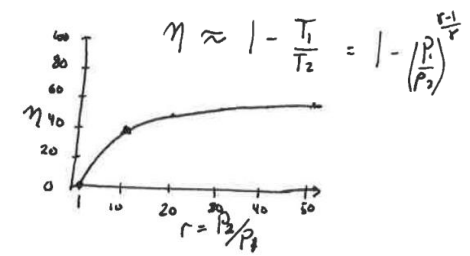
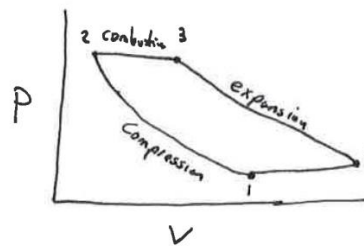

Compressor Combustion Turbine

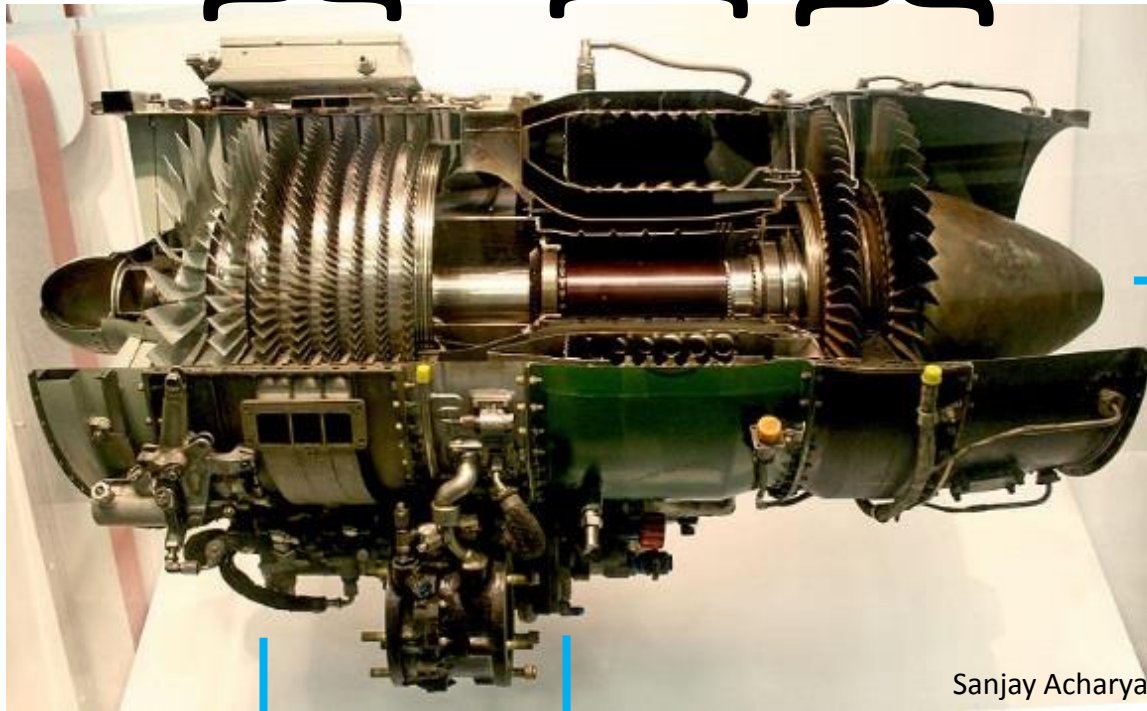

Inlet Flow

Outlet Flow

Low P
Bleed

High P
Bleed

Sanjay Acharya

Bleed air is used for pressurization, power production, de-icing, starting, cooling, etc.

The price to pay is less mass flow rate available as thrust.

Case Study: TWA 800 (Boeing 747)

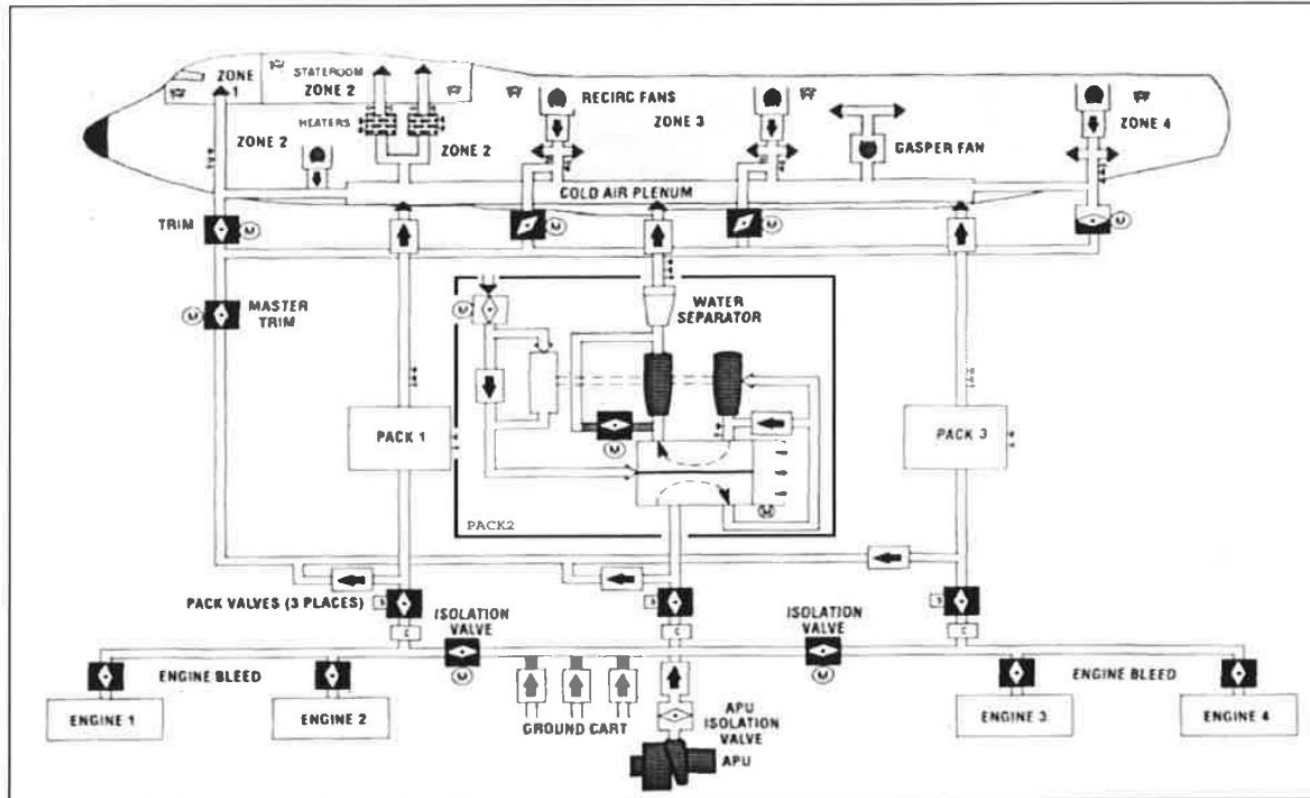
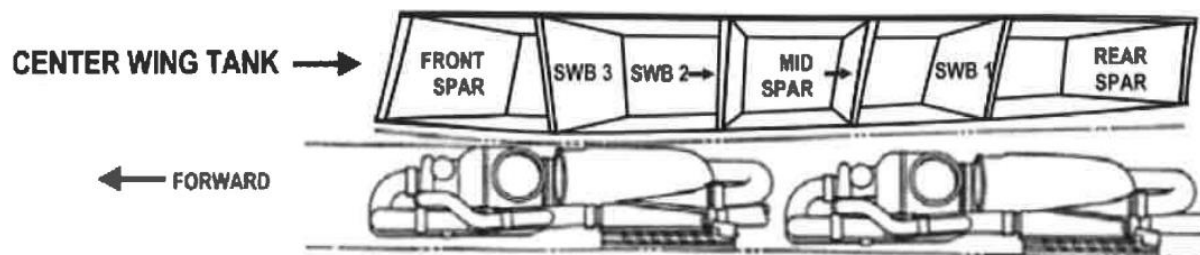

Figure 6. A schematic diagram of the 747-100's air conditioning system.



TWA 800 B 747 1996

Aircraft destroyed in crash off the coast of Long Island NY after takeoff from JFK.

An unusual flight path and multiple fireballs contributed to speculation of ...



The NTSB report says: "An explosion of the center wing fuel tank (CWT), resulting from the ignition of the flammable fuel/air mixture in the tank. The source of ignition energy for the explosion could not be determined with certainty, but, of the sources evaluated by the investigation, the most likely was a short circuit outside of the CWT that allowed excessive voltage to enter it through electrical wiring associated with the fuel quantity indication system.

Contributing factors to the accident were the design and certification concepts that fuel tank explosions could be prevented solely by precluding all ignition sources and the design and certification of the Boeing 747 with heat sources located beneath the CWT with no means to reduce the heat transferred into the CWT or to render the fuel vapor in the tank non flammable.

Visual translation

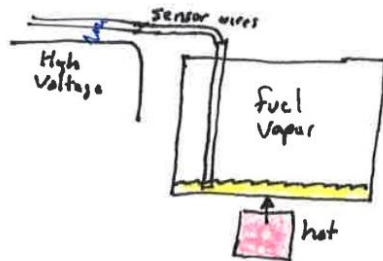

Case St': Boeing 737

Huge success: 10000+ delivered over 50 years
Up to 200+ seats, twin engine, efficient



By Konstantin von Wedelstaedt



Air conditioning



Pneumatics

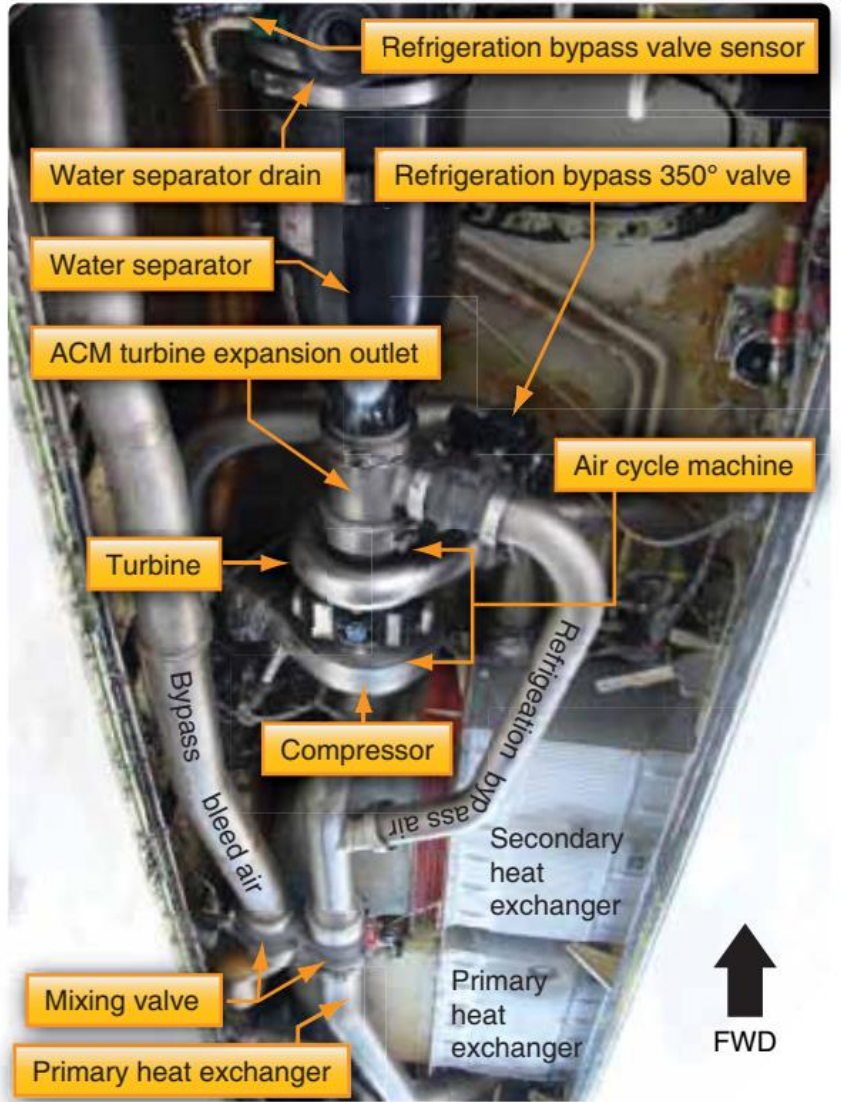
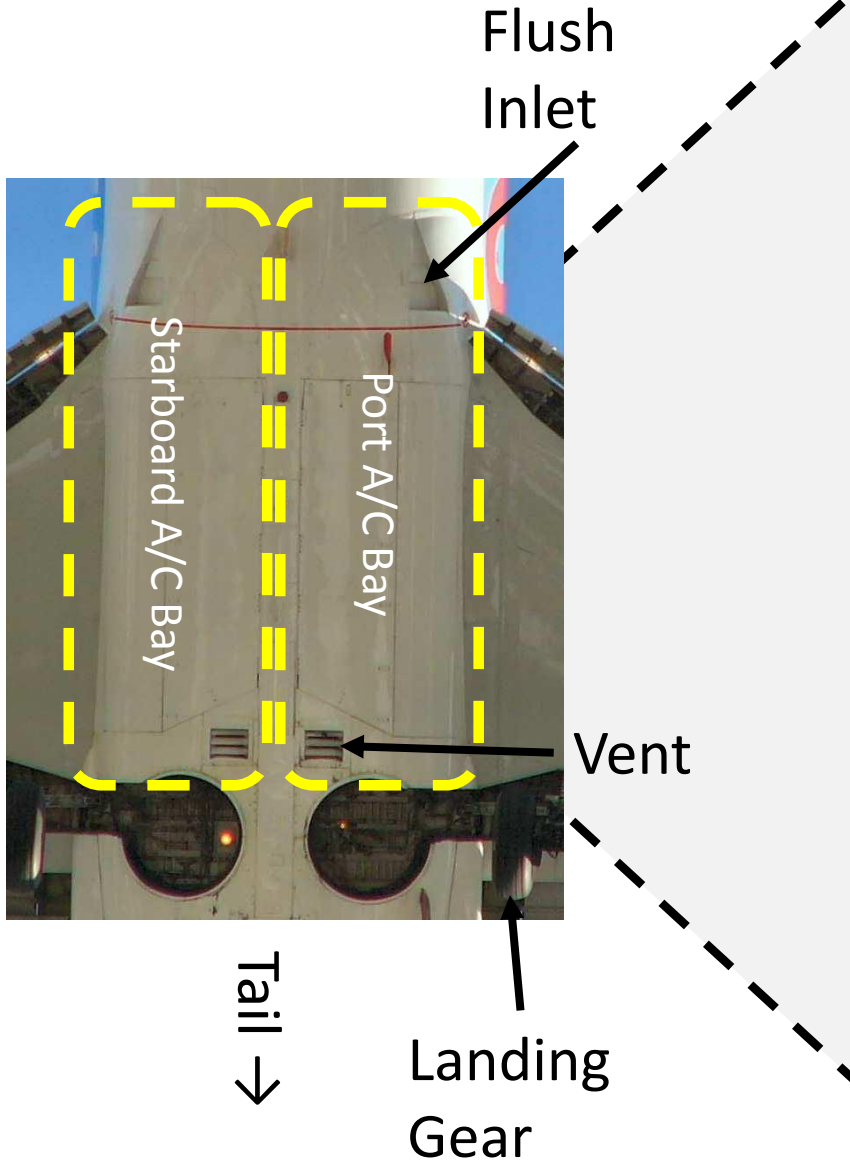

Source: FAA

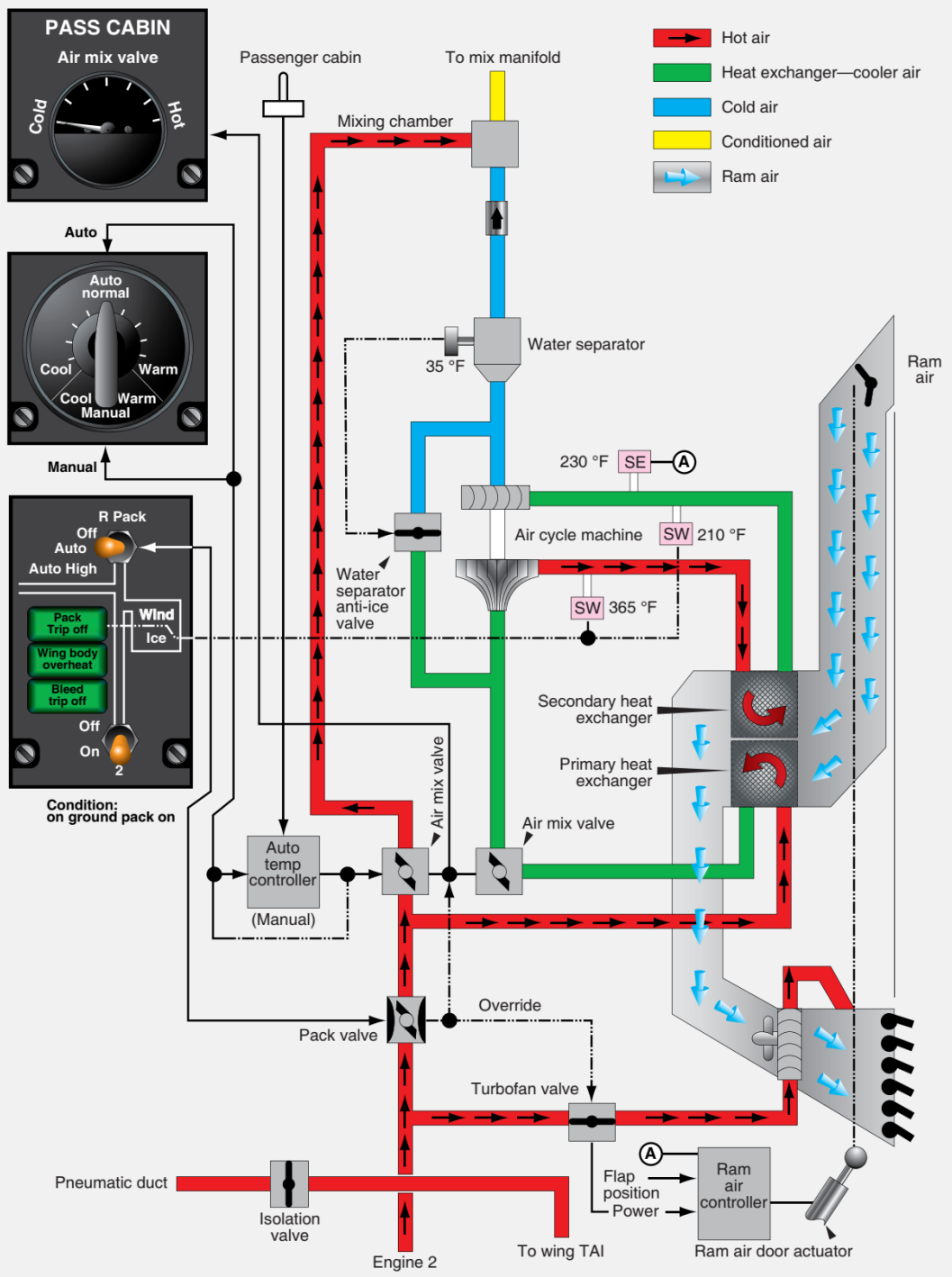

Source: FAA

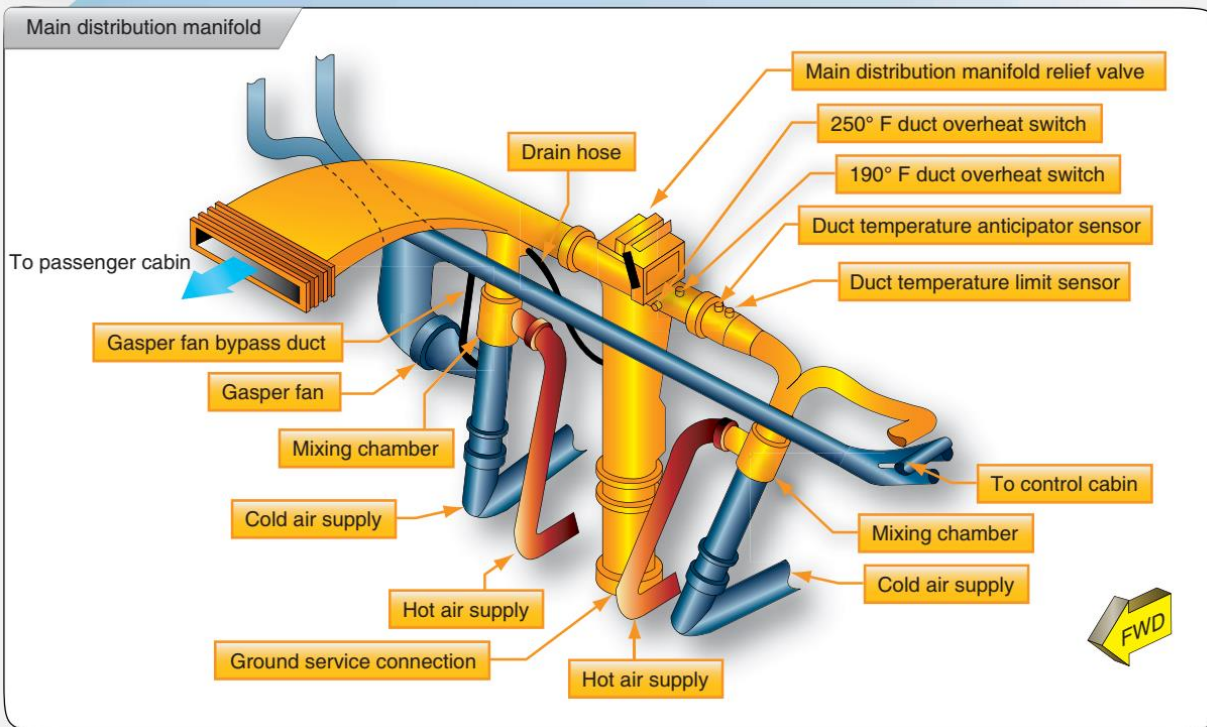
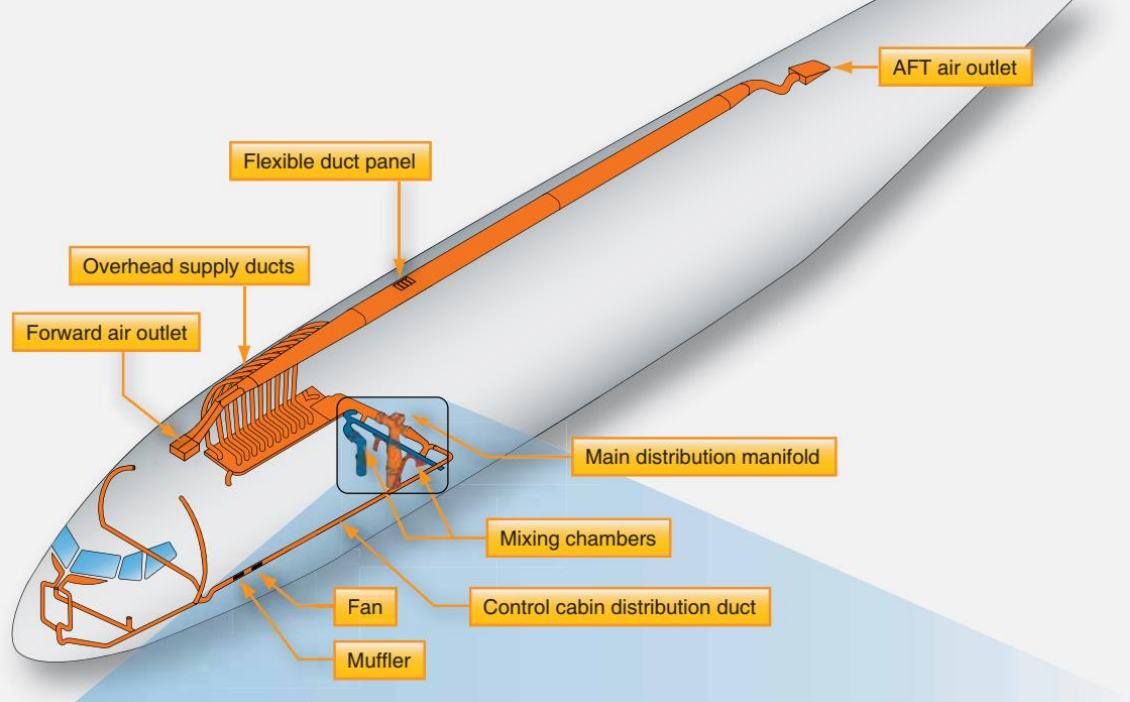

Pressurization:



Failure Mode? Loss of Pressurization



Helios 522

Payne Stewart

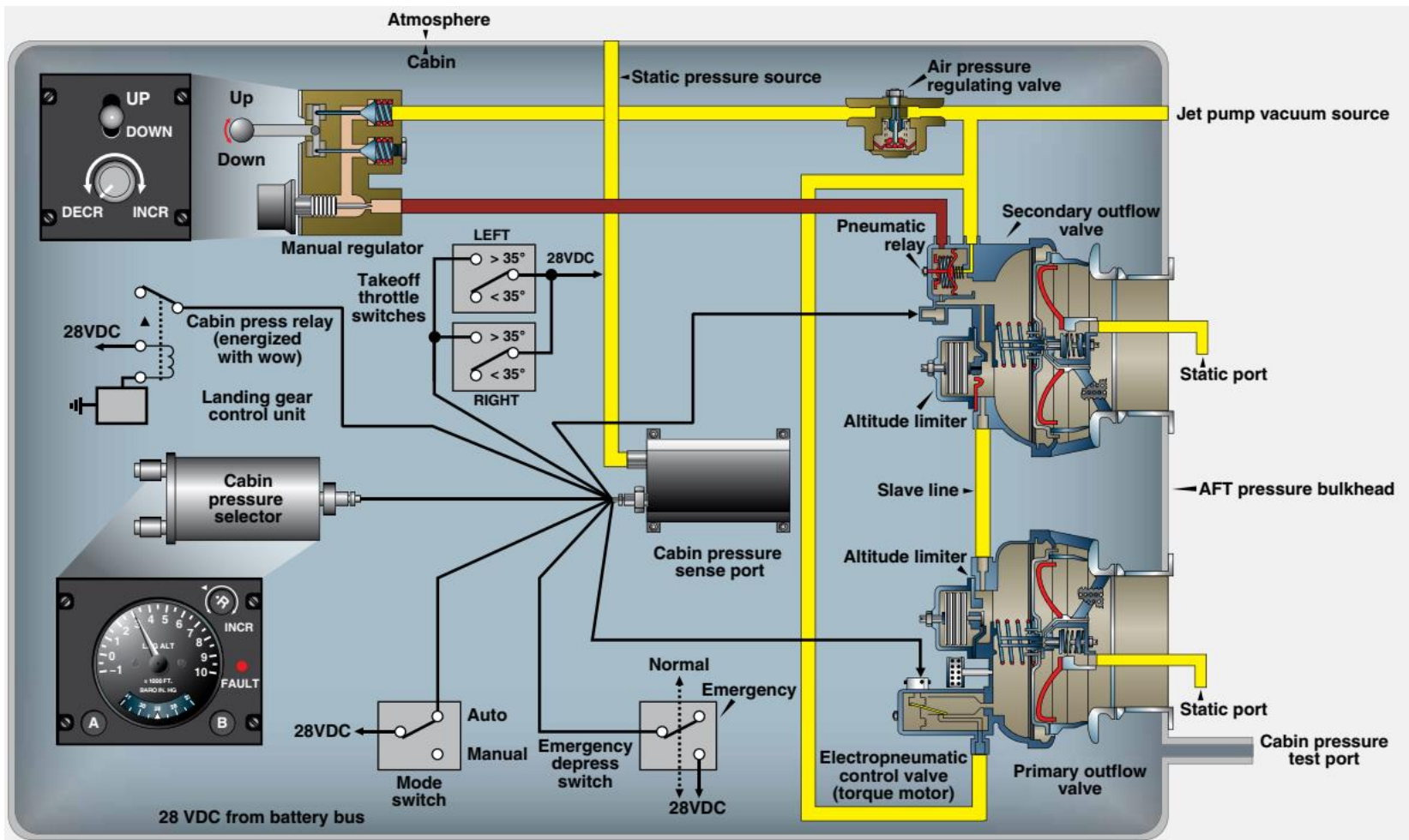

The Future?

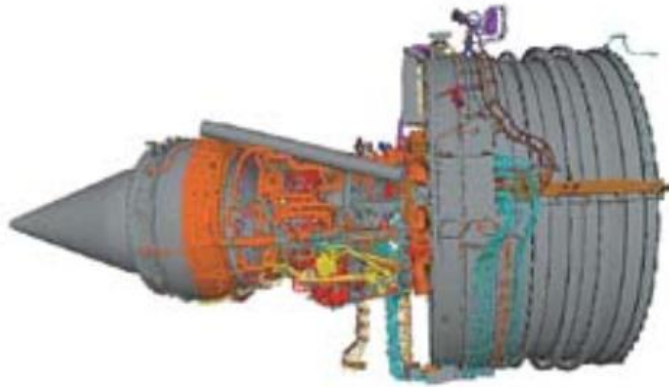

No bleed system

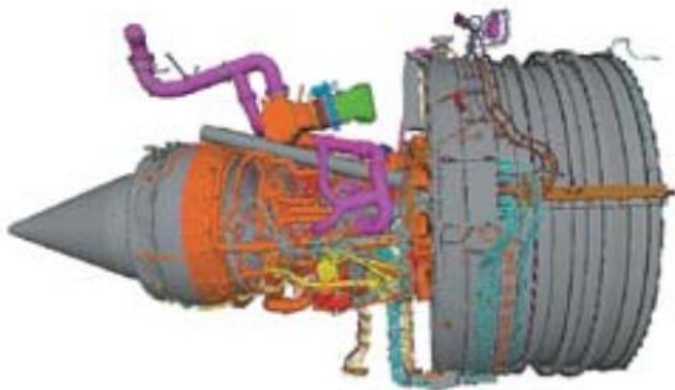

Traditional Bleed System

787 No-Bleed Systems: Saving Fuel and Enhancing Operational Efficiencies

by Mike Sinnett,
Director, 787 Systems

The primary differentiating factor in the systems architecture of the 787 is its emphasis on electrical systems, which replace most of the pneumatic systems found on traditional commercial airplanes.

One of the advantages of the no-bleed electrical systems architecture is the greater efficiency gained in terms of reduced fuel burn — the 787 systems architecture accounts for predicted fuel savings of about 3 percent. The 787 also offers operators operational efficiencies due to the advantages of electrical systems compared to pneumatic systems in terms of weight and reduced lifecycle costs.

In the no-bleed architecture, electrically driven compressors provide the cabin pressurization function, with fresh air brought onboard via dedicated cabin air inlets. This approach is significantly more efficient than the traditional bleed system because it avoids excessive energy extraction from engines with the associated



Contact:

Dr. Charles O'Neill

Remote Sensing Center

University of Alabama

croneill@eng.ua.edu

<http://aero.ua.edu>

Slides Posted at: <http://tiny.cc/ECSLecture>